

- INSTRUCTION MANUAL -

NOC WALL BUTTON

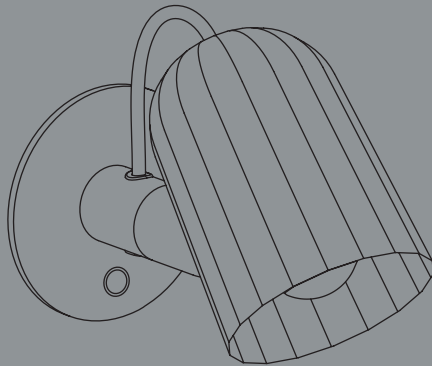

DESIGN BY SMITHMATTHIAS

HAY

- GENERAL INFORMATION -

TECHNICAL DATA

This product is fitted with an E14 bulb fitting. HAY recommends using this product with a LED bulb.

FITTING TYPE | LED E14

POWER (W) | 5,5W

COLOUR TEMPERATURE | Warm white

HAY will not accept any responsibility for any accidents, injuries or damages that occur due to the use of incorrect bulbs.

ATTENTION

Ensure that the power supply to the circuit has clearly been turned OFF before installing the product. In some countries, electrical installation must be carried out by authorised electricians/contractors; please check with your local authority for guidance.

The product must not be modified in any way. HAY accepts no responsibility for any products that have been modified or tampered with. If the external flexible cable or cord of this luminaire is damaged, it should be exclusively replaced by a qualified electrician in order to avoid an electrical hazard. This lamp is designed for indoor use only.

CARE AND MAINTENANCE

The product can be cleaned with a soft damp cloth and mild detergent, or a dry microfibre cloth. Do not use alcohol or any other solvents to clean the product and avoid using abrasive or rough sponges. Ensure that the power supply has been turned OFF before cleaning the product.

- PARTS -

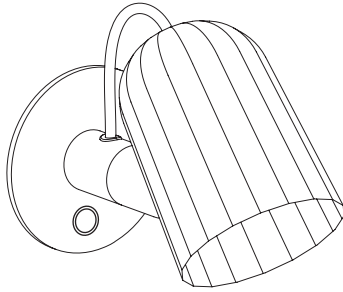

Lamp



Mounting plate

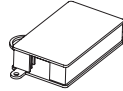

Connector box



Wall plugs



3 x screws

1.

Unpack all the parts and check that you have received all the parts listed. Using the mounting plate as a guide, mark the position of the holes to be drilled (50mm apart). Drill the holes and insert wall plugs. Ensure you use the correct type of wall plug for the material you are drilling into.

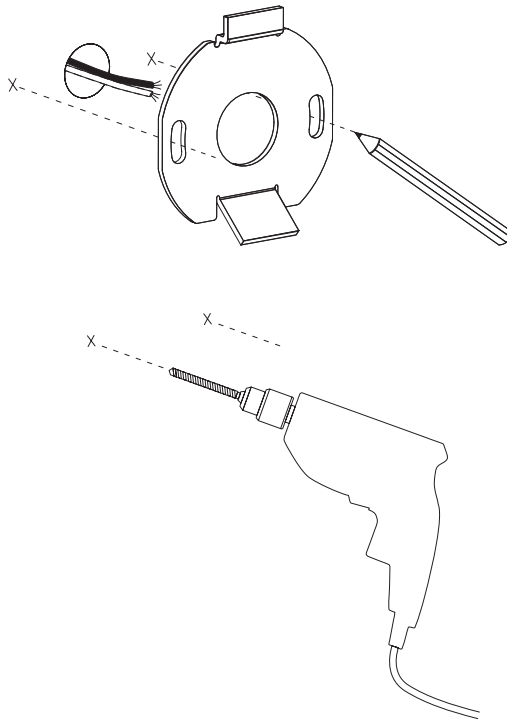

2.

Feed the mains supply cable through the insulating tube into the connector box.

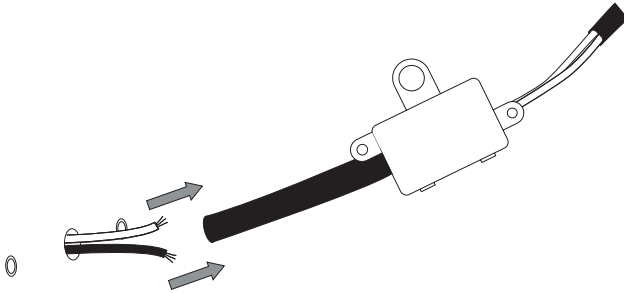

Ensure the power is switched off!

3.

Open the connector box and connect the mains supply cables to the corresponding cables on the light. Close and secure the connector box, making sure that the insulating tube covers the wire supply from the wall.

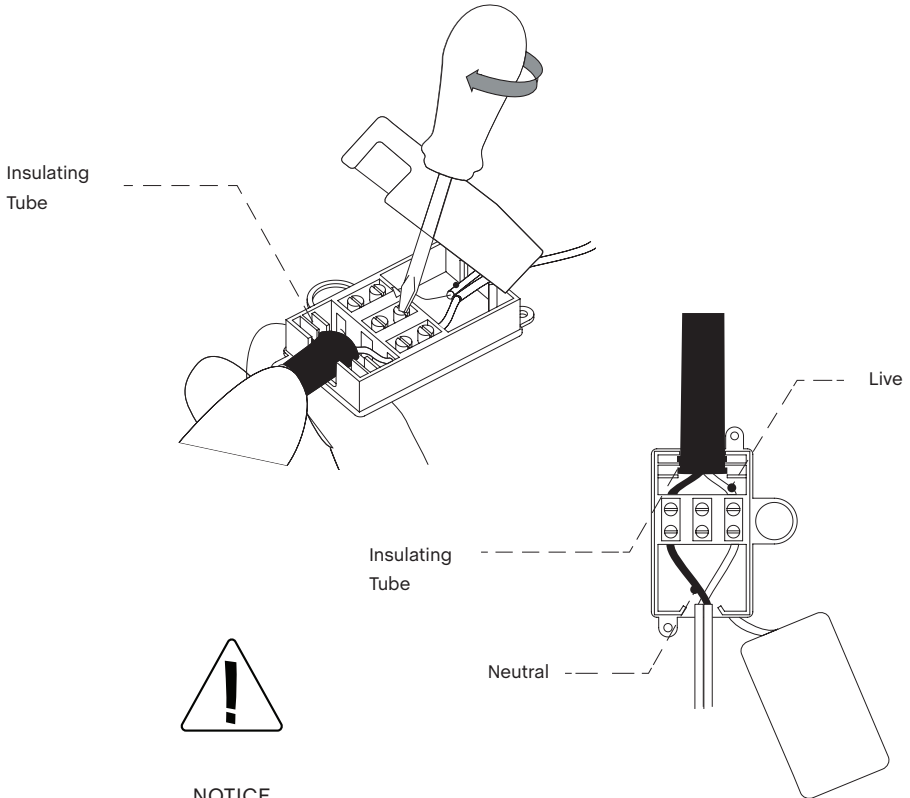

NOTICE

It is recommended that a qualified electrician connects the power in this step.

4.

Fix the mounting plate onto the wall using the provided screws.

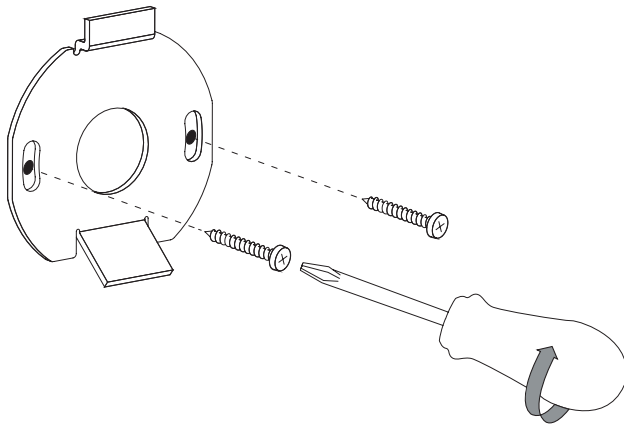

5.

Place the lamp over the mounting plate, ensuring it is properly positioned on the upper tab of the mounting plate.

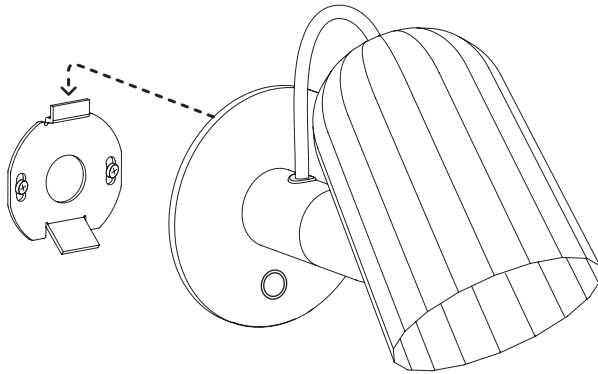

6.

Insert and tighten the screw at the bottom of the wall bracket to secure the lamp in place.

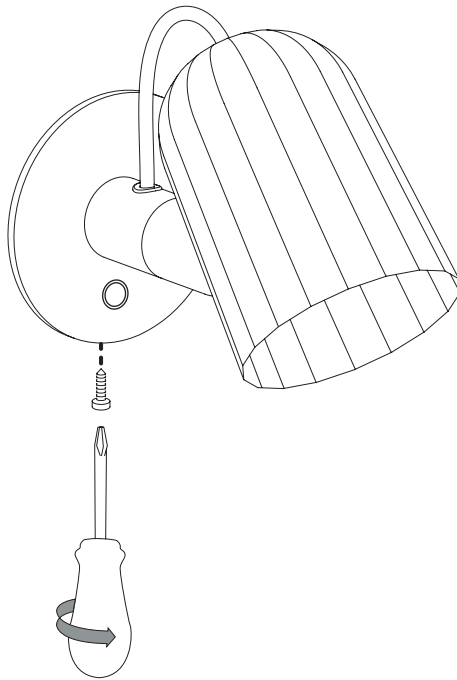

5.

Screw an E14 bulb into the bulb fitting.

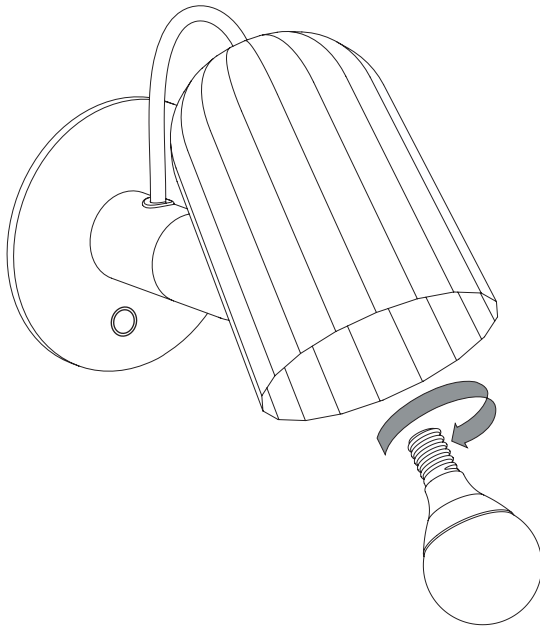

- CARE & MAINTENANCE -

Our Care & Maintenance offers guidance for optimal maintenance of your HAY product. It includes advice and instructions on cleaning and caring for specific materials to prolong the life of your lighting.



Please find our Care & Maintenance guide by scanning the QR code



You can find more relevant information on Noc Wall Button by scanning the QR code

You can also find the same information here
hay.dk/downloads

Havnen 1 8700 Horsens Denmark
+45 4282 0282 / hay@hay.com

www.hay.com

02/05/2022

HAY